

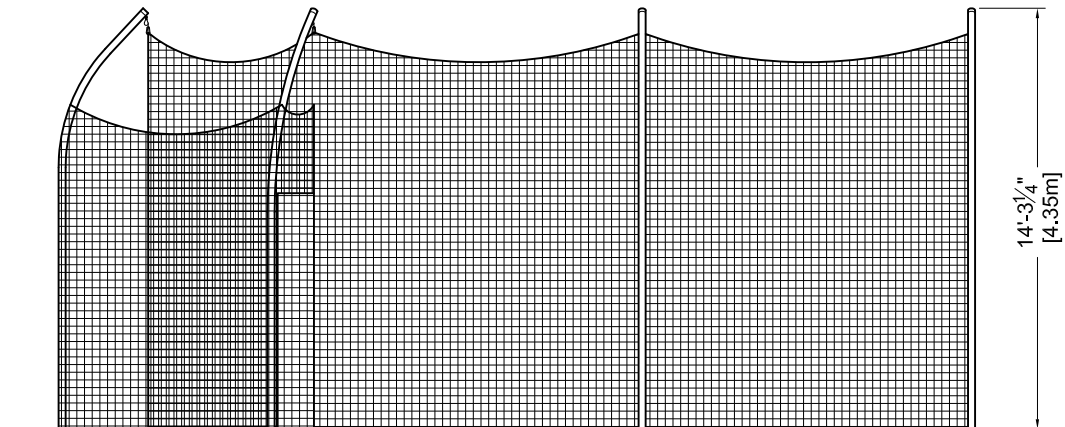

www.gillathletics.com
800-637-3090

8021 - HIGH SCHOOL DISCUS CAGE WITH REAR ENTRY SYSTEM SPECIFICATIONS

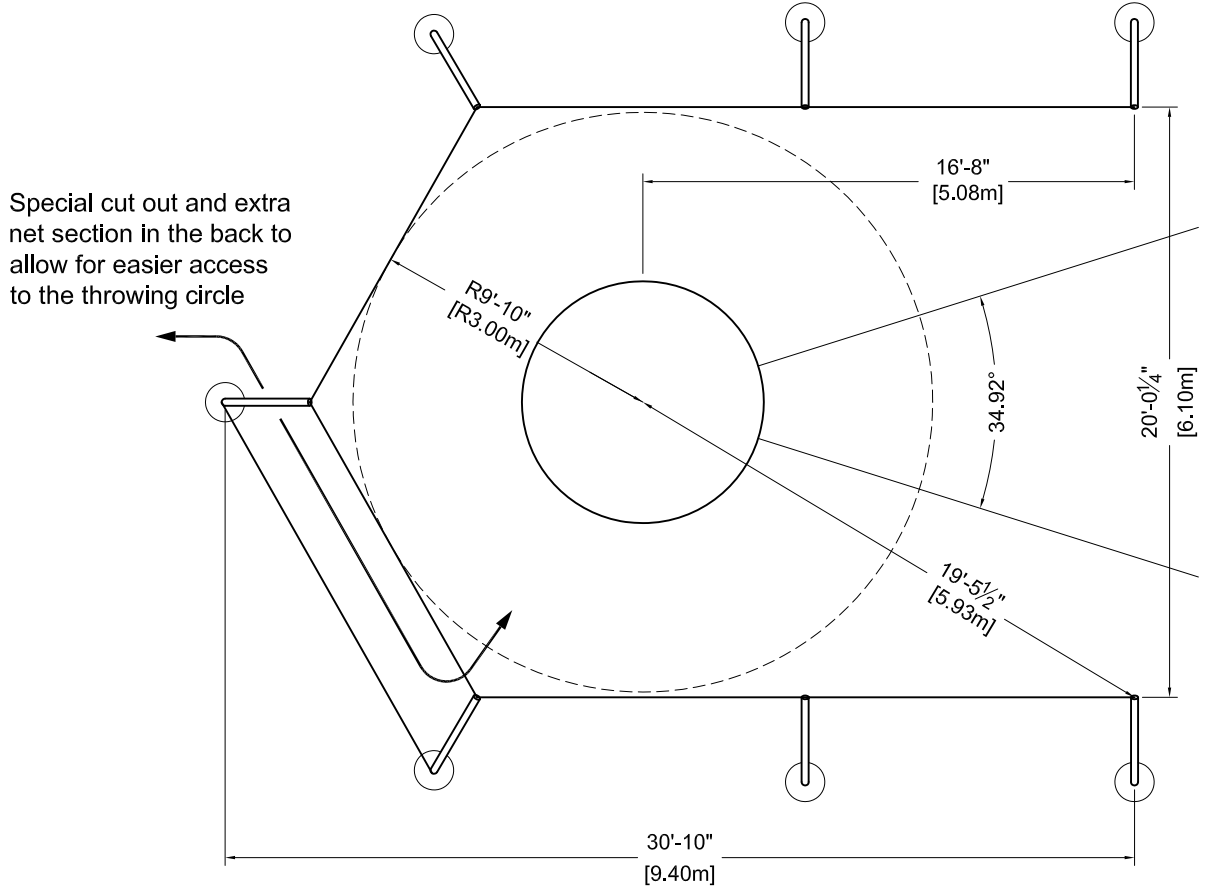

The 8021 High School Discus Cage with Rear Entry System, consists of seven, 14 foot tall, rolled aluminum net poles with ground sleeves, a vinyl coated net support cable to reduce net sag, and a weather treated nylon net. Hinged net arms, at ground level, hold the net in place at the front of the cage. The poles are 2 7/8" OD, 0.203 wall, 6063-T6 aluminum tube. Each pole stands in a 30" deep ground sleeve. The net is 180 lb. test nylon which has been weather treated for extended service life. The net has a special cut out and extra section in the back to allow for easier access to the throwing circle.



www.gillathletics.com
800-637-3090

8021 - HIGH SCHOOL DISCUS CAGE WITH REAR ENTRY SYSTEM GROUND SLEEVE INSTALLATION

1. Stake out and mark with string the sector center line crossing the circle center. Stake out a second line perpendicular to the sector center line at the circle center. Measure and mark the sleeve centers for each post as shown below.

2. Dig seven 34" deep holes at marked locations. The minimum recommended diameter of these holes is 18". Soil conditions at your sight may require larger diameter concrete bases for each pole.

3. Place approximately 4" of rock in the bottom of each hole. The rock should support the sleeve at the proper height and allow water in the sleeve to drain away.

4. Mark the hole centers with crossed strings. Set each ground sleeve in place so the top edge is 1/2" above the surrounding ground level. Position the sleeves so the poles will face in the directions indicated by the arrows as shown. Note the detail showing the orientation of the sleeve pin to the pole axis arrow. As the sleeves must remain vertical, secure them in place with wire and short sections of rebar.

5. Carefully pour cement around the ground sleeves. Check with a level to ensure sleeves have remained vertical. The concrete should slope away from the top edges of the sleeves to ground level to help keep water and debris out of the sleeves.

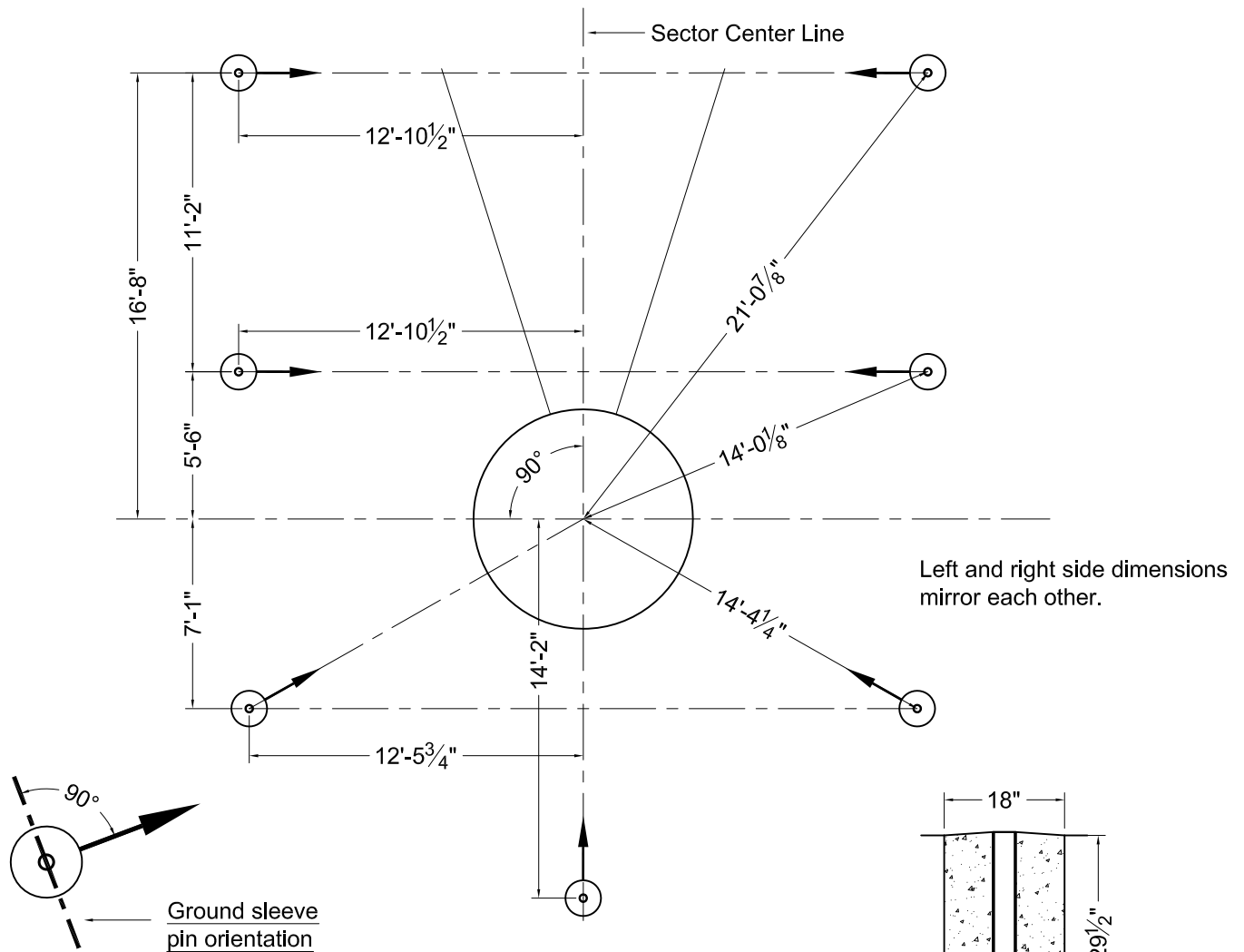

NOTICE: All installations should be conducted by experienced contractors and in accord with all applicable codes, laws and regulations. Suggested instructions herein are illustrative only and should be adapted to suit local requirements. Gill Athletics is not responsible for the manner in which these products are installed.



www.gillathletics.com
800-637-3090

802020 - CAGE NET POLES NET POLE ASSEMBLY

1. Install pulley assembly at the top of the net pole with 1/4" nylock hex nuts (M1290). The gap in the eye of the bolt should face up. Install the black pole cap (M429). The thread on these eye bolts can be trimmed after installation, if so desired.
2. Install the eyebolt (M2749) at the lower hole with nylock nut (M1290). The thread on these eye bolts can be trimmed after installation, if so desired.
3. Cut each 50' rope (M2005) in half and melt ends to prevent fraying. Tie one end to snap hook (M2223) and feed the other through the pulley and lower eyebolt. Tie the loose end to the rope cleat to prevent the rope from being lost when lowering the net.
4. Insert the net pole into the ground sleeve so that the curve of the pole is towards the inside of the cage.
5. Install net flip arms (73210043) on the front poles with u-bolt (M2298), washers (M2263), and 1/2"-13 nuts (M2233). After the net is raised, clip the bottom rope edge of the net to the end of the net flip arm.

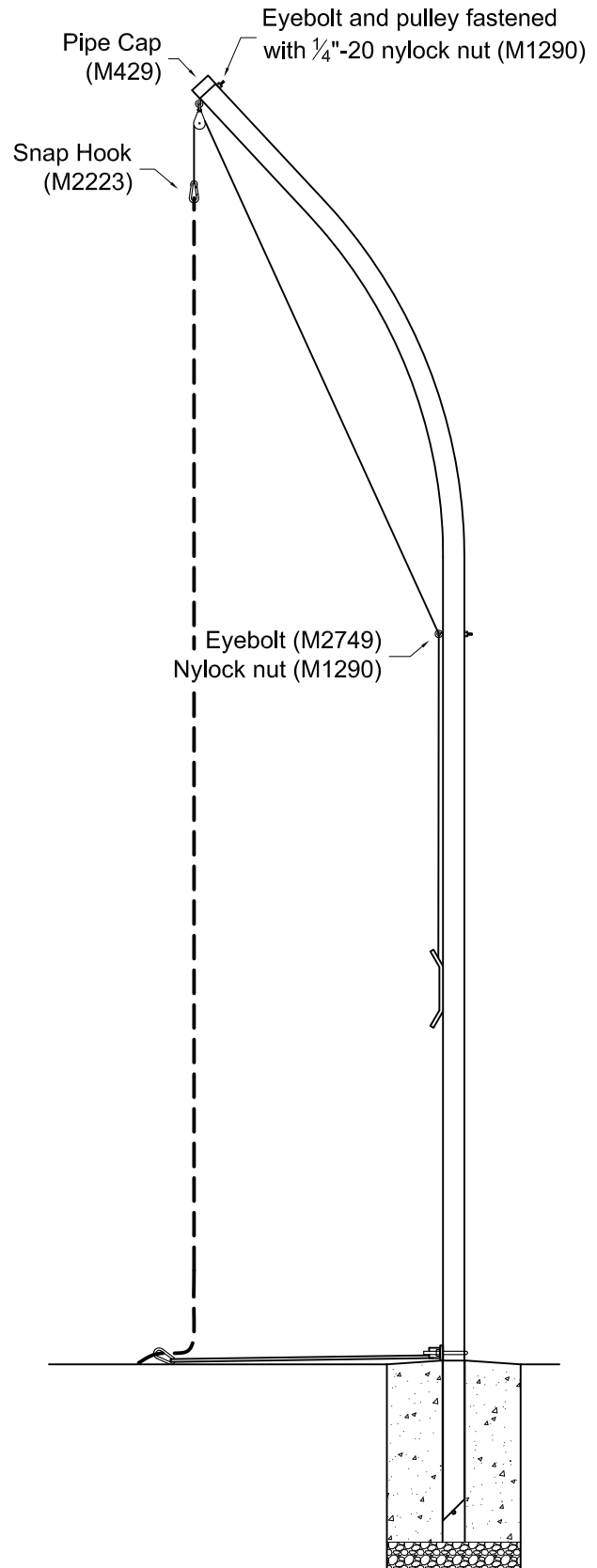



www.gillathletics.com
800-637-3090

8021 - HIGH SCHOOL DISCUS CAGE WITH REAR ENTRY SYSTEM NET INSTALLATION

1. To minimize sag, the net is supported by a vinyl coated steel cable. To install the cable, weave it in and out through every 5th net opening just below the top edge of the net. When finished, the loops at each end of the cable should be even with the ends of the net.
2. To ensure the net is evenly spaced when it is installed, mark each hook position on the net according to the diagram below. Stretch the net out flat and stake one upper corner to the ground along with the end of a 100 ft. long measuring tape. Stretch the net and tape to 68' 6" and stake the corner to hold it's position next to the tape. Mark the top of net and the cable at the dimensions shown.

4. Lay out the net inside the cage poles with each marked position next to the appropriate net rope hook. At each position hook both the net binding and the cable. At each end be sure the hook is through the cable loop.

5. Raise the net to the top of the poles and tie off the ropes. At the base of the front poles, hook the bottom corner of the net to the flip arm. A sand bag or other weight can be placed on the arm to increase the arms resistance. If you desire, additional net flip arms can be purchased. At the rear poles, use the net stakes to hold the bottom of the net in place on the ground. The bottom 6" of the net is supposed to lay on the ground to help trap a discus.

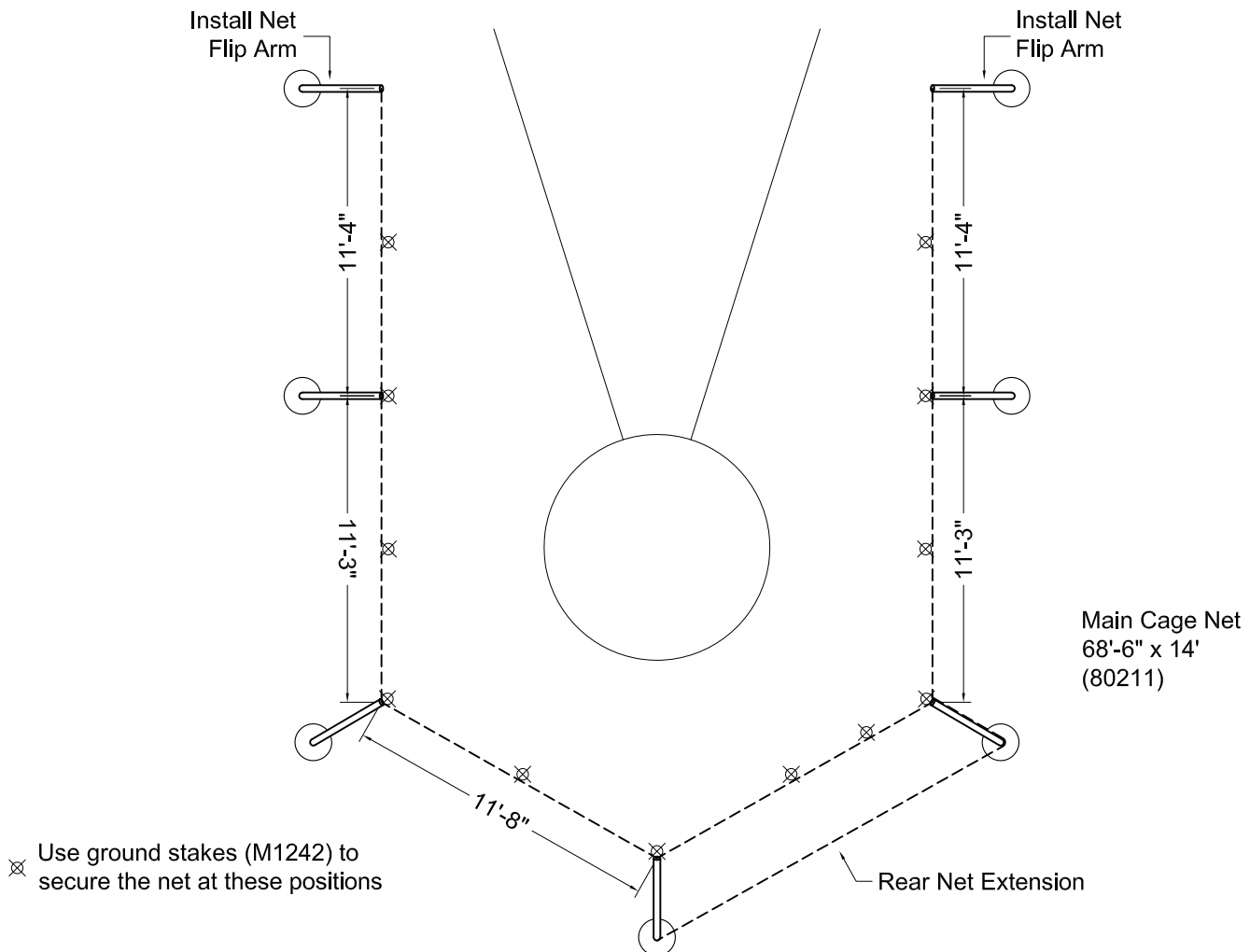



www.gillathletics.com
800-637-3090

8021 - HIGH SCHOOL DISCUS CAGE WITH REAR ENTRY SYSTEM NET INSTALLATION

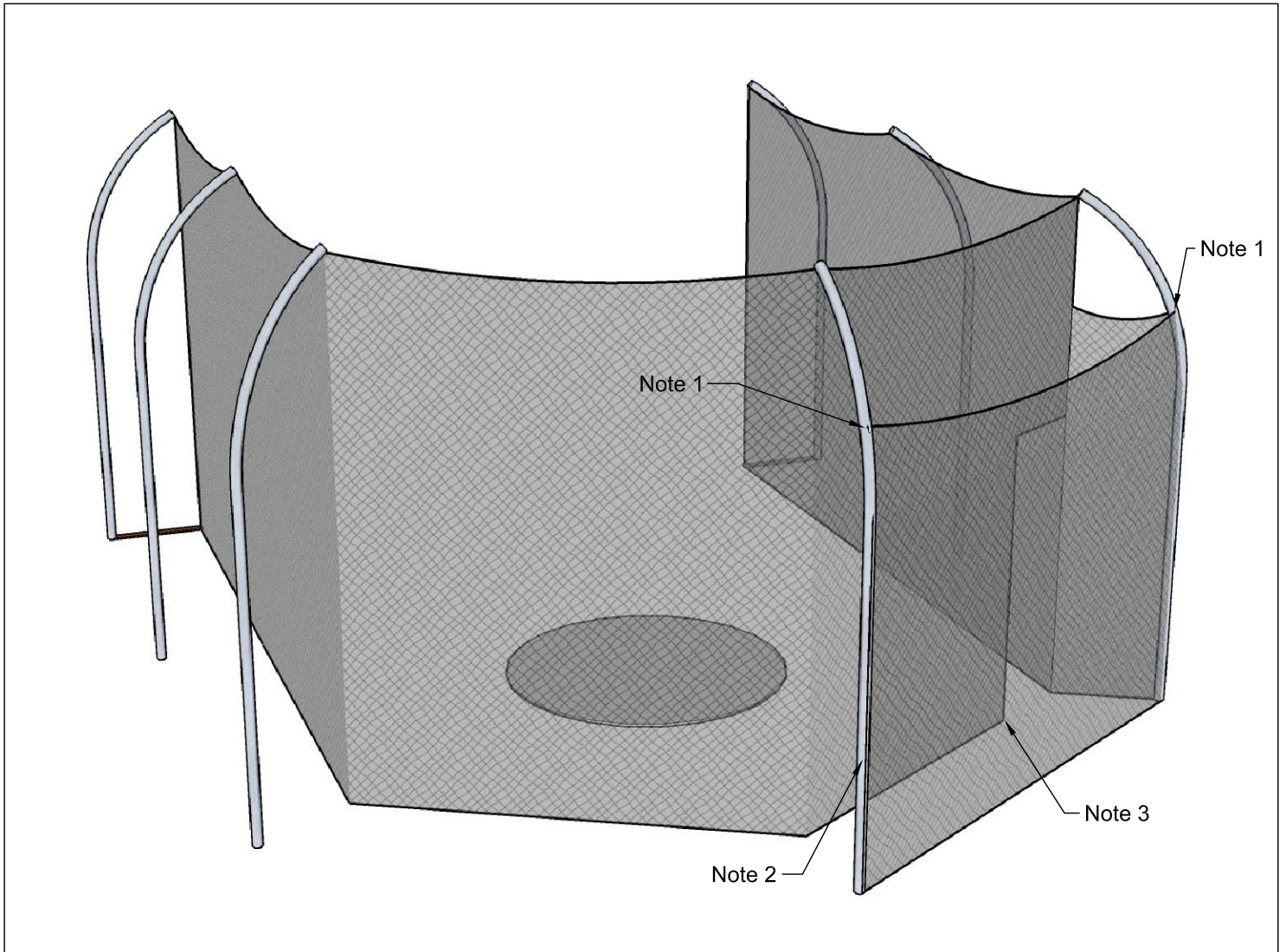

NOTES:

1. Measure up from the ground 11ft and drill $\text{Ø}\frac{9}{32}$ " holes through both poles. Install 4" long eyebolts (M2749) with $\frac{1}{4}$ "-20 nylock hex nuts (M1290). Wrap the rear access net extension around the outside of the two net poles. Hook the net to the poles at the eyebolt 11ft from the ground using snap hooks (M2223).
2. Lace the entire end of the net extension to this pole using rope.
3. Secure the bottom corner of the net next to the entry way with a ground stake (M1242) to keep the net from moving in the wind.



www.gillathletics.com
800-637-3090

8021 - HIGH SCHOOL DISCUS CAGE WITH REAR ENTRY SYSTEM SHIP LIST

Main Net
80211
x1

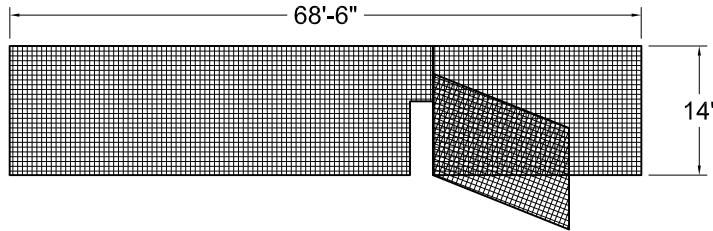

Net Pole
802020
x7

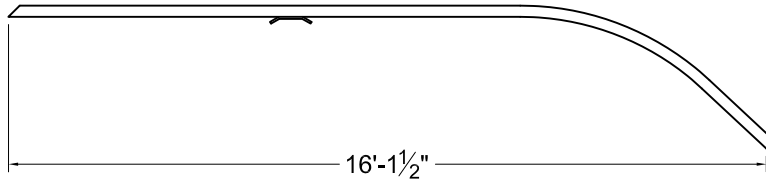

Ground
Sleeve
802025
x7

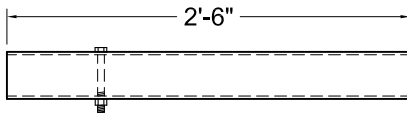

Cage Components Box - 802140

Warning Sign
M2322
x3



Snap Ring
M1250
x12

1/4" Polyester Rope
M2005
(25ft Sections)
x8 sections

Ground Stakes
M1242
x12

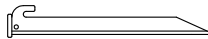

Net Support Cable
68' Long
802048A
x1

Pipe Caps
M429
x7



Net Arm
73210043
x2



HARDWARE BAG x 1:		
QTY.	M#	DESCRIPTION
16	M1290	1/4"-20 Nylock Hex Nut
7	M2729	*Pulley for 1/4" Rope
16	M2749	*1/4"-20 x 4" Eyebolt
9	M2223	3/8" Snap Hook

* The pulleys must be assembled onto four of the eyebolts.



www.gillathletics.com
800-637-3090

THROWING CAGE INSTALLATION OF WARNING SIGNS

For the protection of athletes, spectators, and coaches install warning signs according to the diagram below.

Attach signs (M2322) to the cage net with the included 1.25" rings (M1250) in each corner. Signs should face away from the cage toward spectators.

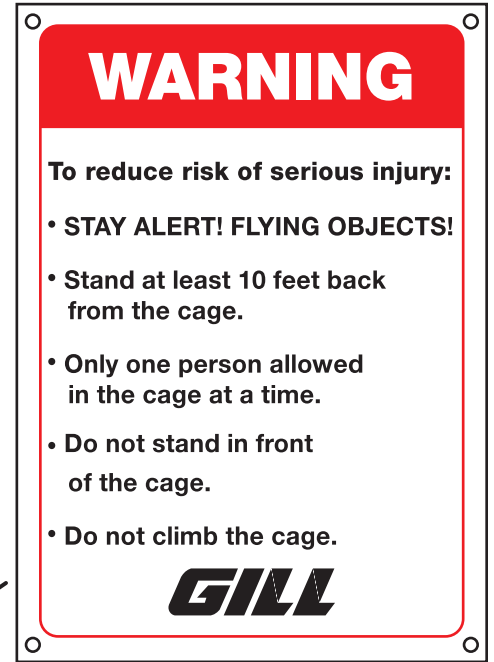

Center Back: Attach sign to the outside of the net at eye level in the middle of the back of the cage.

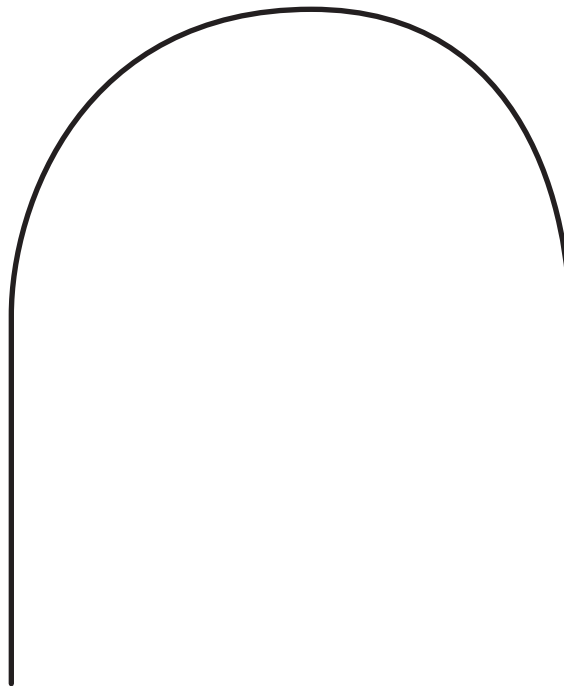

Left Front Side: Attach sign to the outside of the net at eye level near the front left side of the cage.



Right Front Side: Attach sign to the outside of the net at eye level near the front right side of the cage.





www.gillathletics.com
800-637-3090

BACK DOOR DISCUS CAGE BARRIER NET NET INSTALLATION

Discus cage size and layout will vary depending on model number.

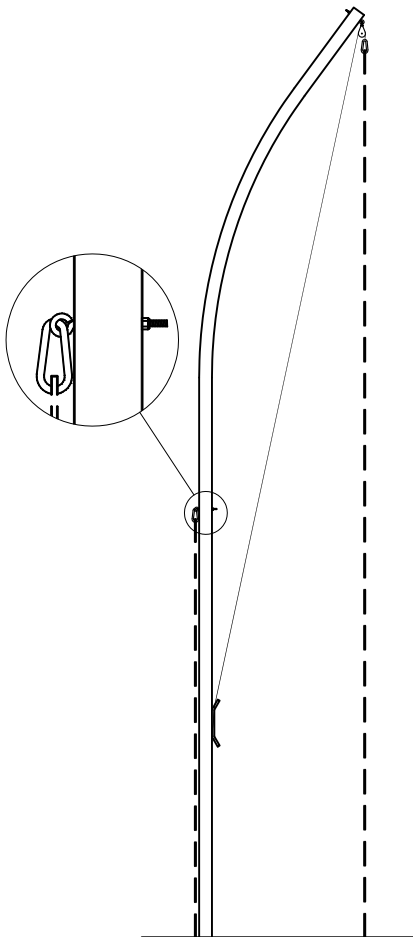
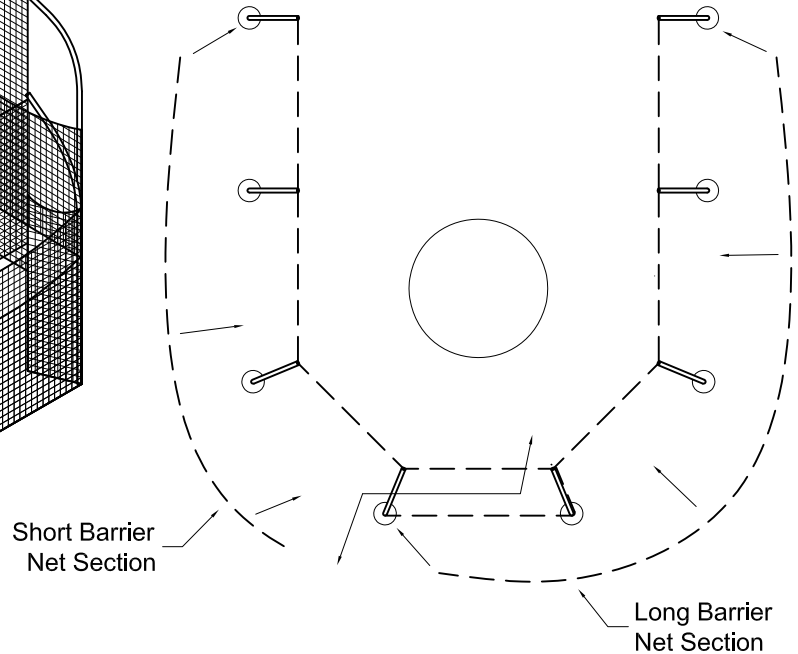
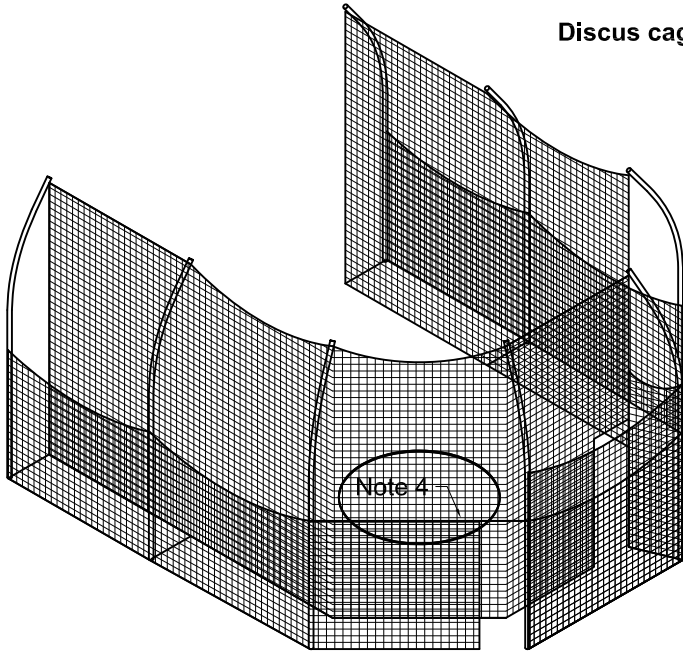

The barrier net wraps around the outside of the cage poles and is 8 feet tall.

The barrier net improves safety by keeping spectators from standing up against the outside of the main net.

However it does not eliminate the possibility of injury, everyone involved with the discus throw from spectators to athletes must show proper judgment.

NOTE:

1. The discus cage barrier net consists of two net sections, a net support cable, and connecting hardware.
2. If not already installed, install eyebolts in all of the net poles and door poles at 8 feet above the ground. The eye of the eyebolt should be on the outside of the discus cage.
3. Starting at the door poles, hang the barrier net from the eyebolts using snap hooks.
4. At the end of the short section, lace the net support cable through the top of the barrier net. Connect the net support cable to both poles. Do not connect the end of the short net section to the net pole, this will leave an opening to the rear access of the discus cage. See top left drawing.

GILL ATH
10/01/09